



EN

**SCT.2421.M**

**User Manual**

**Thermostats**



# Warnings

**Before using the device, read the user manual carefully and follow the instructions.**

**Responsibility for damages, losses and personal accidents caused by not following the warnings in the user manual belongs to the user. In this case, the device is out of warranty in case of malfunctions.**

The device must be used in accordance with the instructions. There should be no electricity in the connecting cables during assembly. The device must be protected from moisture, vibration and pollution. Attention should be paid to the operating temperature.

Shielded and twisted cord cable should be used for input and output lines that are not connected to the mains. These cables should not be passed near high power lines and devices. The shield line must be grounded at the device side. Installation and electrical connections must be made by technical personnel in accordance with the instructions in the user manual.

Before starting the assembly of the device, it should be visually checked against any damage that may occur during transportation. Installation and commissioning must be done by mechanical and electrical technicians. This responsibility belongs to the buyer.

If there is a danger that may arise from any error or malfunction on the device, turn off the energy of the system and disconnect all electrical connections of the device from the system.

There is no switch on the device to turn off the device's energy. A switch and fuse must be added to the system by

the user to turn off the energy at the supply input of the device.

It is necessary to check the supply voltage range of the device and apply the appropriate supply voltage. This control process will prevent damage to the device or system and possible accidents by applying the wrong supply voltage.

In order to prevent electric shocks and similar accidents, the device and the installation system should not be energized before all connections of the device are completed.

Do not modify or attempt to repair the device. Interventions on the device may cause malfunction of the device, damage to the device and the system, electric shocks and fire.

Never use the device in environments where flammable and explosive gases are present.

Necessary precautions must be taken regarding all parts that may pose a danger to the mechanical part where the device will be mounted. These precautions are necessary for the safety of the personnel who will do the installation.

The device must be mounted on the system with its own fixing parts. Do not assemble the device with unsuitable fixing parts.

**In case the device is used for purposes other than those specified in this user manual, all responsibility belongs to the user.**

**The Warranty period 2 (two) years from the date of purchase of the device.**

## 1. Thermostat

### 1.1. SCT.2421 Series Thermostats



- ❖ 3.2" LCD Display
- ❖ Touch Button
- ❖ Auto/Manual Fan Operation
- ❖ Heating/Cooling/Auto Modes
- ❖ Keylock
- ❖ 1pcs Analog 0-10V Outputs
- ❖ 2pcs Digital Relay Outputs
- ❖ Can be integrated into building management systems via Modbus/RTU (Optional)
- ❖ Real Time Clock (Optional)
- ❖ Minimum and Maximum Set Temperature Limit
- ❖ Weekly program

## 2. Technical Dimensions:

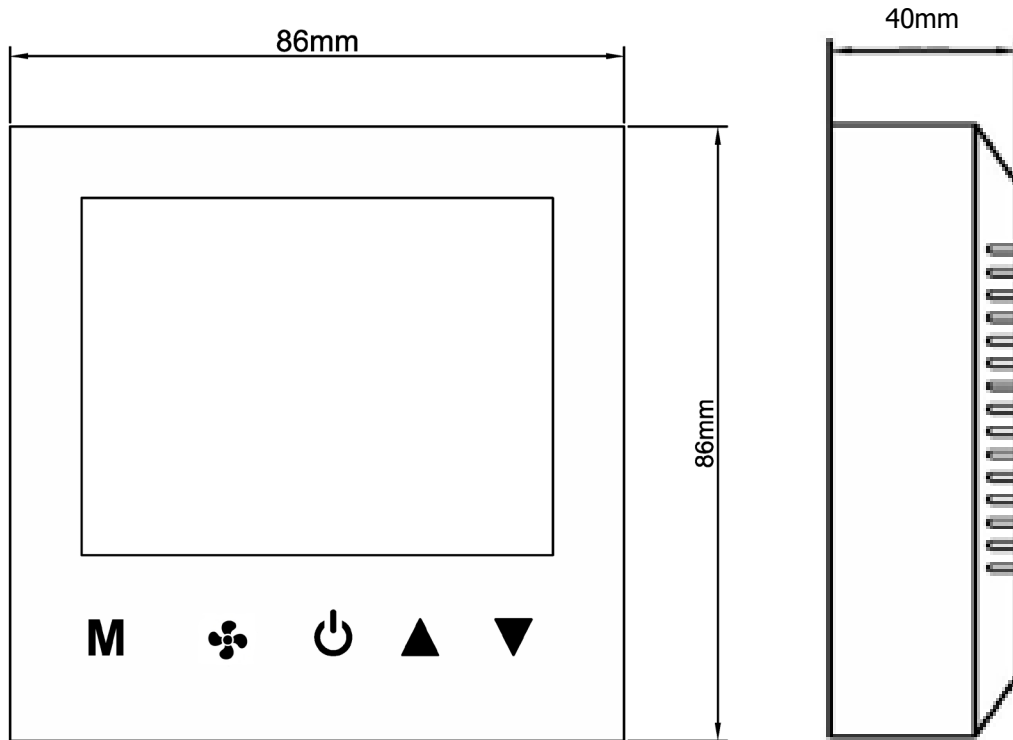





### 3. Technical Specifications

<b>Electrical Data</b>	Supply	24 VAC/VDC
	Power consumption	Max 1VA
	Connection	1,5mm <sup>2</sup> Terminal Connector
<b>Functions</b>	Analog Output	1 Piece (0-10V)
	Digital Output	2 Piece Digital Relay Outputs
<b>Physical Data</b>	Mounting Type	Wall Mounting
	Dimensions	W86XH86xY40mm
	Weight	140 Gr
<b>Environmental Data</b>	Operating, Storage Temperature	0... +40°C/0... +70°C (Without Icing and Condensation)
	Protection Class	IP20 according to EN 60529 standard

## 4. Functional Features:





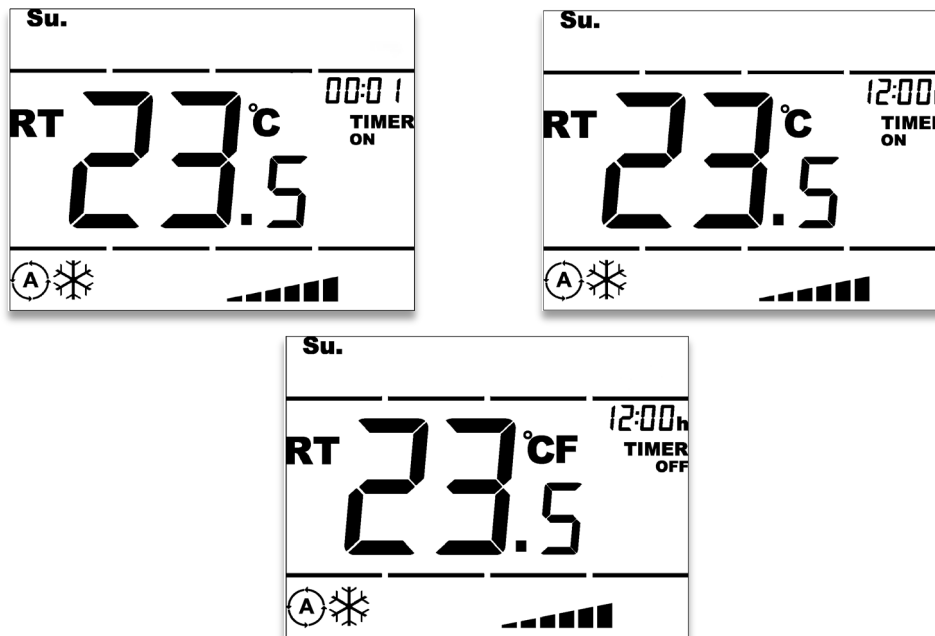

- ❖ Heating, Cooling and Auto Mode
- ❖ Manual/Auto Fan Mode
- ❖ 1 Output Analog 0-10V Outputs (Fan Control&Valve Control)
- ❖ 2 Digital Relay Outputs
- ❖ Analog output range selection (seperate for Heating and Cooling modes)
- ❖ 6 Stage Fan Speed Control
- ❖ Real Time Clock
- ❖ Weekly Program
- ❖ Automatic Fan Speed
- ❖ Can be Integrated in to Building Management Systems Via Modbus/RTU
- ❖ Configurable User Parameters

## 5. Room Panel Use

-  **On/Off Button** : Manages the ON/OFF functions of the device.
- M** **Mode/OK Button** : Selects the operating mode of the device (Automatic Heating/Automatic Fan/Manual).
-  **Up Button** : Increases Set Temperature
-  **Down Button** : Decreases Set Temperature Setting
-  **Fan Button** : Changes Fan Level

### How to Set Weekly Schedule?



- ❖ Press the **M(MODE/OK)** button through the panel for 2 seconds while the device is on.
- ❖ With the parameter number '0' selected, press the **M(MODE/OK)** button.
- ❖ Set the day you want to set with the **UP**  and **DOWN**  buttons and press the **M(MODE/OK)** button.
- ❖ When **TIMER ON** is written, set the start time with the **UP**  and **DOWN**  buttons and press the **M(MODE/OK)** button.
- ❖ When **TIMER OFF** is written, set the end time with the **UP**  and **DOWN**  buttons and press the **M(MODE/OK)** button.
- ❖ Press **ON/OFF**  button to return to the main screen.

**Note1:** If the start time is after the end time, the device remains turned off for the selected day.

**Note2:** If the start time and end time are the same, the weekly schedule application for the selected day will not work.

**Note3:** If the device has a weekly schedule setting for the current day, the time logo appears and works on the screen during scheduled working hours.

## How to Set Date and Time?

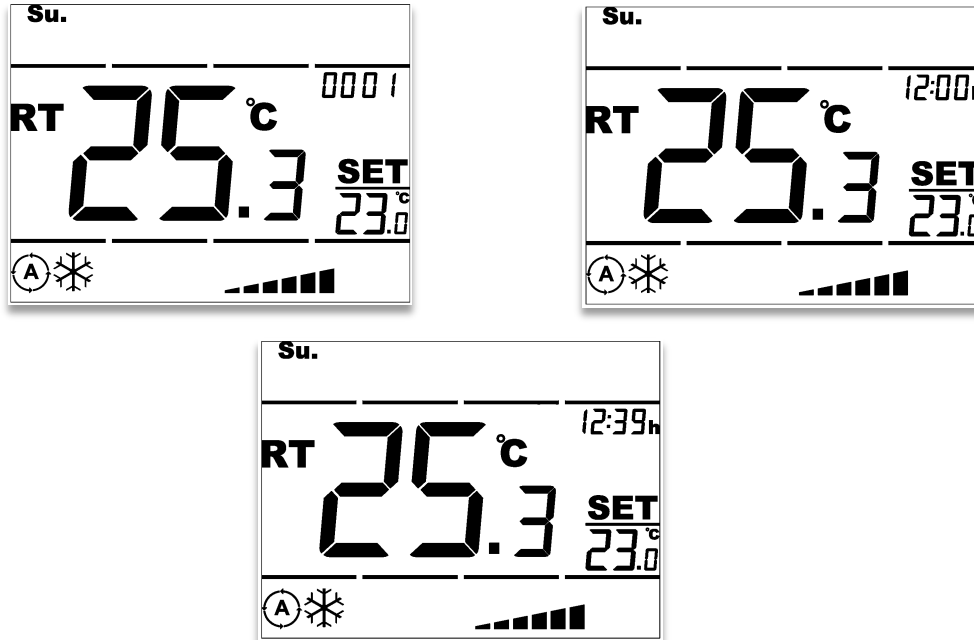

- ❖ Press the **M(MODE/OK)** button through the panel for 2 seconds while the device is on. Point to parameter 1 with the **DOWN** ▼ button and press the **M(MODE/OK)** button.
- ❖ Select the **DAY** and **MONTH** setting with the **UP** ▲ and **DOWN** ▼ button and proceed using the **M(MODE/OK)** button.
- ❖ Select the **YEAR** setting with the **UP** ▲ and **DOWN** ▼ button and proceed using the **M(MODE/OK)** button.
- ❖ Select the **TIME** and **MINUTE** setting with the **UP** ▲ and **DOWN** ▼ button and proceed using the **M(MODE/OK)** button.
- ❖ Select the day with the **UP** ▲ and **DOWN** ▼ button and proceed using the **M(MODE/OK)** button. You can return to the home screen with the **ON/OFF** button.

## How to Change Device Mode?

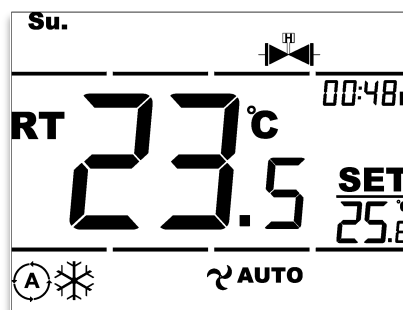

- ❖ Mode selection can be made by pressing the **M(MODE/OK)** button on the panel while the device is on. If the device is in Manual Heating, Manual Cooling Automatic or Fan mode, the fan steps are adjusted by pressing the **FAN** button, and the set temperature is adjusted with the **UP** ▲ or **DOWN** ▼ buttons.

## How to Change Set Temperature?

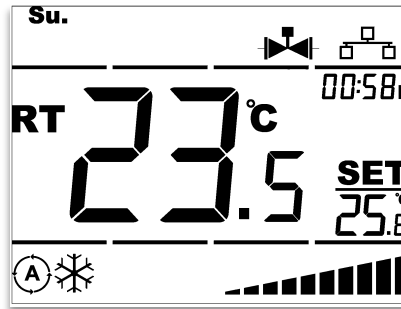

- ❖ When the device is on, the device is adjusted in manual or automatic heating or cooling mode with the **UP** ▲ or **DOWN** ▼ buttons.

## How to Turn Off Key Lock On?

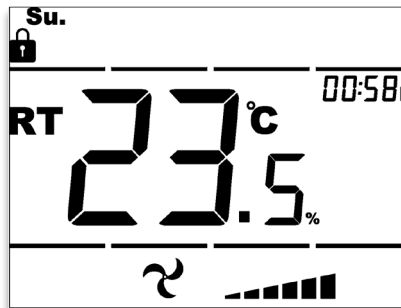

- ❖ The key lock is unlocked by pressing the **FAN** ↻ button for 5 seconds when the device is on.

## How to Turn Off Key Lock Off?

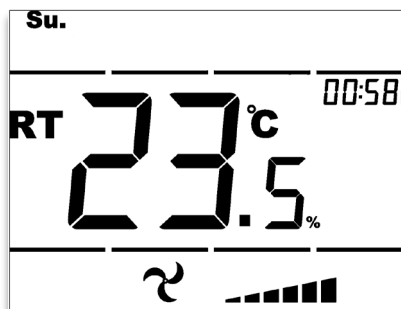

- ❖ The key lock is unlocked by pressing the **FAN** ↻ button for 5 seconds when the device is off.

## How to Adjust Screen Brightness?

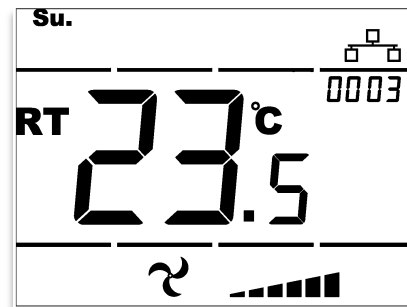
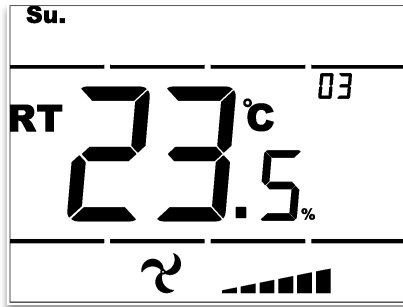

- ❖ When the device is on, press the **M(MODE/OK)** button for 2 seconds. In the settings menu, parameter 2 is entered with the **UP ▲** button and the **M(MODE/OK)** button is pressed. After adjusting the Light Intensity, press the **M(MODE/OK)** button.

## 6. Using The Service Menu

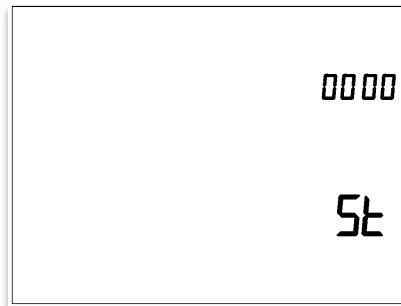

To enter the user service menu:

- ❖ While the device is off, press the **UP** and **DOWN** button for 2 seconds.
- ❖ Enter the user password on the screen that opens and press the **M(MODE/OK)** button.
- ❖ Enter the number of the parameter you want to change on the screen that opens with the **UP** or **DOWN** buttons and press the **M(MODE/OK)** button.
- ❖ On the screen that opens, set the appropriate value of the parameter you want to change with the **UP** and **DOWN** buttons and save it by pressing the **M(MODE/OK)** button.

**Note1: Service menu password is 20.**



**Attention** The changes to be made in the Service Setting Menu must be made by the relevant technical personnel. All responsibility arising from these changes belongs to the person who changed the device parameter.

## SCT.2421.M PARAMETERS LIST V1.0

Par No	Description	Detail	Factory Settings
0	Sensor Calibration	You can callibrate the room temperature by pressing up and down buttons.	0
1	System Selection	You can select the right system for your fan coil system. 0==> 2 Pipe Fan Coil System 1==> 4 Pipe Fan Coil System	1
2	Set Min °C Limiting	Thermostats will off fan and valve at the same time based on the real limit setup temperature. 150==> 15.0°C.	150
3	Set Max °C Limiting	Thermostats will off fan and valve at the same time based on the real limit setup temperature. For 300==> 30°C	350
4	Valve Temperature Diff.(ΔT)	The value difference (ΔT) between the temperature set in the valve output operation of the thermostat and the ambient temperature can be selected. 10=> 1.0 °C	9
5	Auto Mode. Cooling Range Settings	Fully automatic mode cooling dead zone selection 10=> 1.0 °C	5
6	Auto Mode. Heating Range Settings	Fully automatic mode cooling dead zone selection 10=> 1.0 °C	5
7	Fan Temperature Diff.(ΔT)	The value difference (ΔT) between the temperature set in the fan output operation of the thermostat and the ambient temperature can be selected. 10=> 1.0 °C	9
8	Fan Stage Difference Adjustment. (ΔT)	The difference between the fan stages of the thermostat (ΔT) can be selected 10=> 1.0 °C.	10
9	Thermostatic Control	00- Valves and fan stop at the same time 01- Valves Stop but Fan Keeps Running	0
10	Full Auto Mode Fan Stage	You can select the fan step value in full automatic mode. 00- Valves and Fan Stop at The Same Time (Default Mode) 01- In full automatic mode, the fan operates at the 1st stage 02- In the full automatic mode, the fan operates at the 2nd stage 03- In the full automatic mode, the fan operates at the 3rd stage	0

11	Fan/Valve Time	You Can Select Fan/Valve Opening and Closing Time Settings With This Feature	20
12	Door Contact Function	You can select Temperature location and Window / Door Contact output with the up and down buttons. 00- Panel Temp Selection 01- External Temp Selection 02- Panel Temp Selection+Window Contact	0
13	Door Contact NO/NC Selection	You can activate the key card function by pressing up and down buttons. 00- Key Card Output is Normally Open (NO) 01- Key Card Output is Normally Close (NC)	0
14	Door Contact Delay Time	With this Feature, You Can Set The Door Window Contact Signal Detection Time	20
15	Temperature Sensor Filter Value	You Can Change The Temperature Sensor Reading Filter Value. If The Filter Value Increases, The Temperature Value is Read More Slowly.	5
16	Modbus ID	Modbus ID Value: 1-254	1
17	Modbus Baudrate	0: 1200Bps 1: 2400Bps 2: 4800Bps 3: 9600Bps 4: 19200Bps	3
19	Radiator Mode	00- Radiator Mode Off. Fan+Valve Operation 01- Radiator Mode On (Valve Operation Only)	0
20	Valve Relay NO/NC Selection	Relay output selection can be made with the up or down buttons. 00- Valve Output Normally Open (NO) 01- Valve Output Normally Closed (NC)	0
21	Memory Function	Thanks to this feature, you can choose to keep all settings the same in case of power off. 0 - The device continues from where it left off when it is first energized. 1 - When the device is energized for the first time, it starts off.	0
24	Fan Stage 1	You can select fan stage 1 with up and down buttons. 1000=> 10.0V	200
25	Fan Stage 2	You can select fan stage 2 with up and down buttons. 1000=> 10.0V	400
26	Fan Stage 3	You can select fan stage 3 with up and down buttons. 1000=> 10.0V	500
27	Fan Stage 4	You can select fan stage 4 with up and down buttons. 1000=> 10.0V	600

28	Fan Stage 5	You can select fan stage 5 with up and down buttons. 1000=> 10.0V	800
29	Fan Stage 6	You can select fan stage 6 with up and down buttons. 1000=> 10.0V	1000

## 7. Schematic

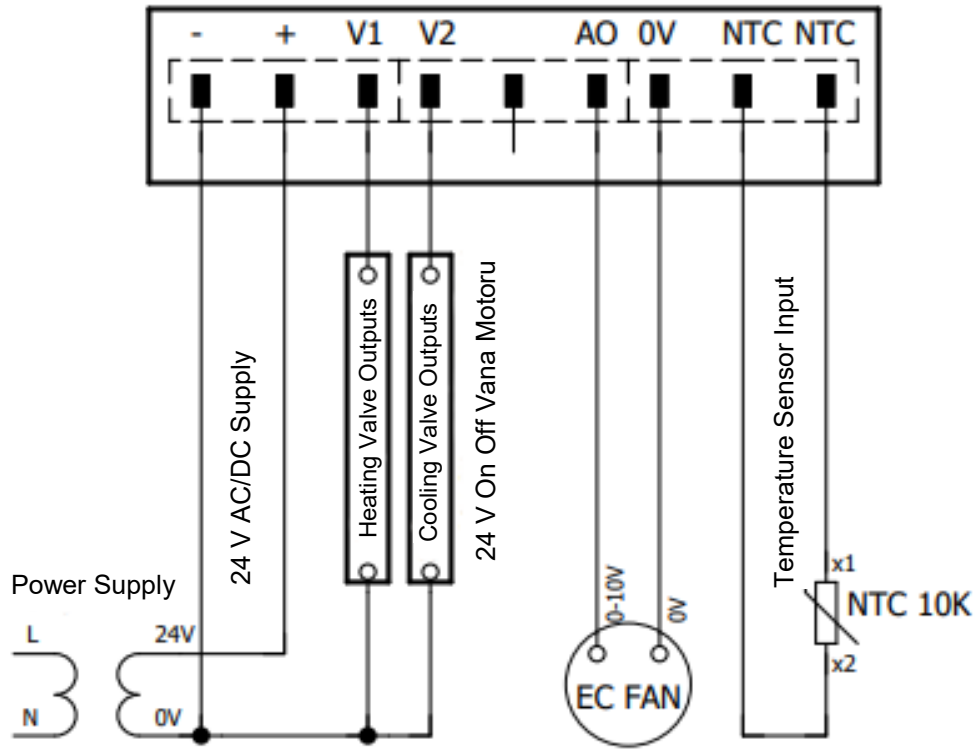

**4 Pipe System Fan Coil Wiring**

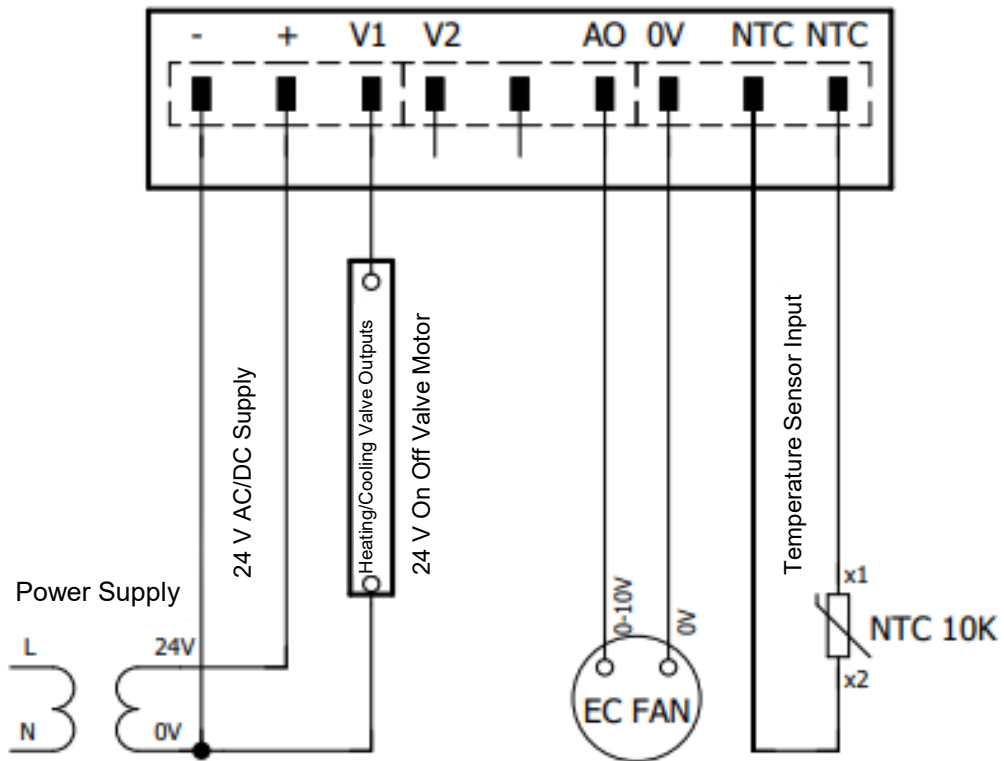

**2 Pipe System Fan Coil Wiring**